

FITTING INSTRUCTION

Clamp mark in acc. with		Cables joining
ISO	PN	
1	L	Left directional lights
2	+	Rear fog lights
3	31	Ground
4	R	Right directional lights
5	58R	Right side parking lights
6	54	Stoplights
7	58L	Left side parking lights

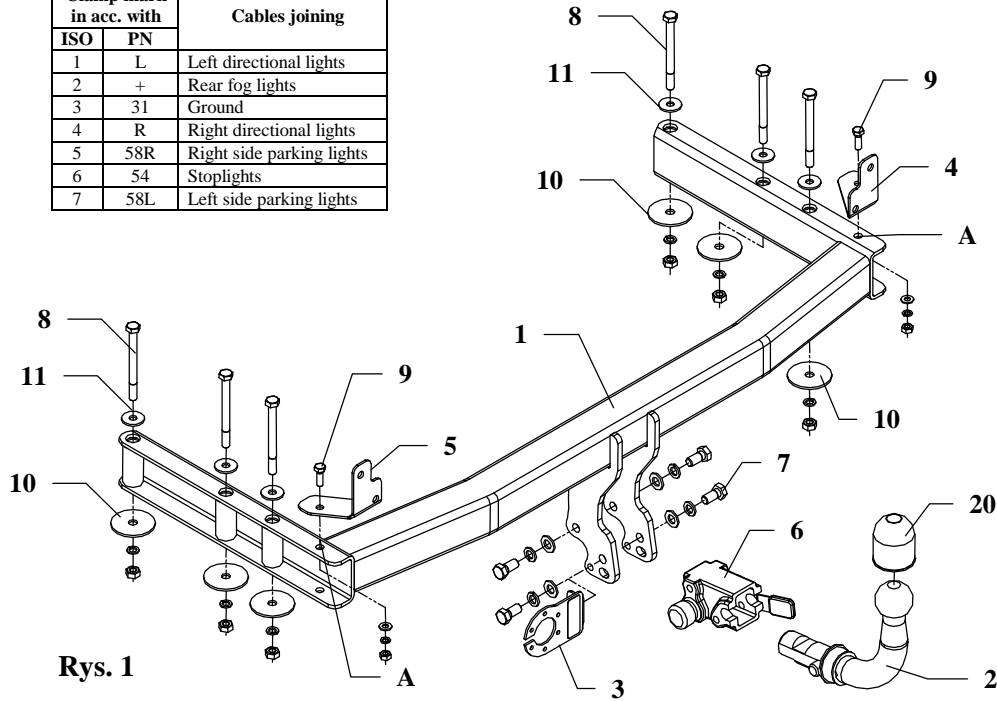

This towbar is designed to assembly in following cars:
AUDI 80 B4, 4 door, Quattro, produced since 09.1991 till 11.1994,
AUDI 80 B4, Avant, Quattro, produced since 09.1991 till 12.1995,
 catalogue no. **A03A** and is prepared to tow trailers max total weight **1700kg** and max vertical load **75 kg**.

Torque settings for nuts and bolts (8,8):

M6 - 11 Nm	M8 - 25 Nm	M10 - 50 Nm
M12 - 87 Nm	M14 - 138 Nm	M16 - 210 Nm

NOTE

After install the towbar you should get adequate note in registration book (at authorised service station). The car should be equipped with:

- Indicators
- Tow mirrors







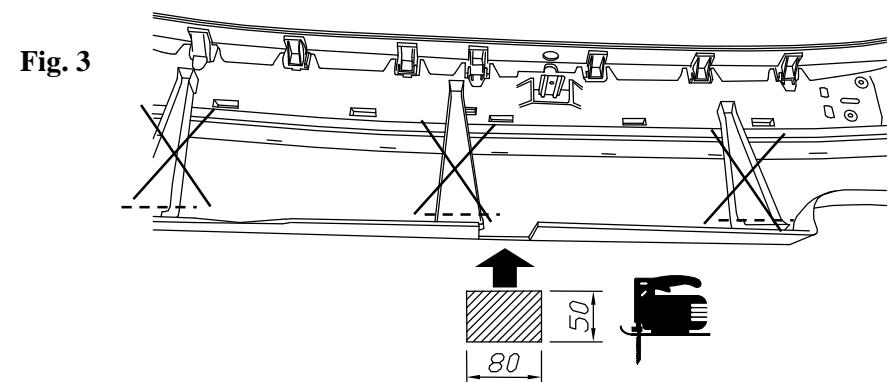
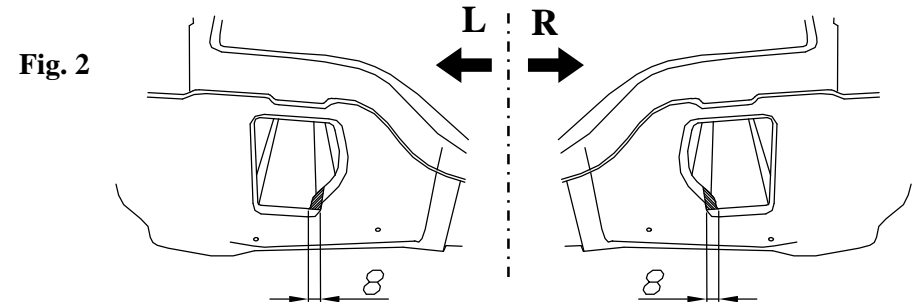



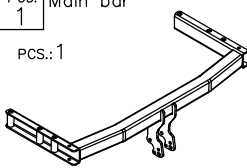



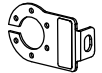
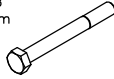

After 1000km check all bolts and nuts. The ball of towbar must be always kept clear and conserve with a grease.

The instruction of the assembly

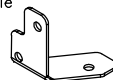
1. To install the towbar you have to disassemble the bumper and next
 - disassemble handles of the bumper
 - cut off three brackets (see figure 3)
 - in bottom edge of bumper, in axis, cut off fragment 50x60mm
2. Enlarge enter of chassis members by cut fragment according to figure 2.
3. Through holes of towbar pos. A fix handles (pos. 4 and 5) using bolts M8x25mm (pos. 9).
4. Fix bumper to the main bar of the towbar using original bolts after disassembling of handles of the bumper
5. Main bar of the towbar together with bumper. slip into chassis members in this way, so holes of towbar agree with original prepared holes and fix from inside bumper using bolts M10x110mm (pos. 8) as shown in figure 1.
6. Tighten all bolts according to the torque shown in the table.
7. Fix body of the automat (pos. 9) and the socket plate (pos. 3) using bolts M12x25mm (pos. 4) from accessories. Place tow-ball (pos. 2) according to supplied instruction.
8. Connect the electric wires according to the instructions of the car. (Recommended to make at service station).
9. Supplement the paint coating damaged during assembly.

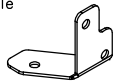

Towbar accessories:

Pos. 1 Main bar PCS.: 1 	Pos. 6 Body of the automat PCS.: 1 	Pos. 12 Plain washer ø13mm PCS.: 4 	Pos. 18 Nut 8 B M8 PCS.: 2 
Pos. 2 Tow ball PCS.: 1 	Pos. 7 Bolt 8,8 B M12x25mm PCS.: 4 	Pos. 13 Plain washer ø8,5mm PCS.: 2 	Pos. 19 Body plug PCS.: 1 
Pos. 3 Socket plate PCS.: 1 	Pos. 8 Bolt 8,8 B M10x110mm PCS.: 6 	Pos. 14 Spring washer ø12,2mm PCS.: 4 	Pos. 20 Ball cover PCS.: 1 
Pos. 4 Right handle PCS.: 1 	Pos. 9 Bolt 8,8 B M8x25mm PCS.: 2 	Pos. 15 Spring washer ø10,2mm PCS.: 6 	
Pos. 5 Left handle PCS.: 1 	Pos. 10 Plain washer ø58xø12x3mm PCS.: 6 	Pos. 16 Spring washer ø8,2mm PCS.: 2 	
	Pos. 11 Plain washer ø30xø10,5x2,5mm PCS.: 6 	Pos. 17 Nut 8 B M10 PCS.: 6 	



PPUH AUTO-HAK S.J.

Produkcja Zaczepów Kulowych
Henryk & Zbigniew Nejman
76-200 SŁUPSK ul. Słoneczna 16K
tel/fax (059) 8-414-414; 8-414-413
E-mail: office@autohak.com.pl
www. autohak.com.pl

Towing hitch (without electrical set)

Class: **A50-X** Cat. no. **A03A**

Designed for:

Manufacturer: **AUDI**

Model: **80 B4**

Type: **4door, QUATTRO**

produced since 09.1991 till 11.1994

Type: **AVANT, QUATTRO**

produced since 09.1991 till 12.1995

Technical data:

D-value: 8,78 kN

maximum trailer weight: **1700 kg**

maximum vertical cup load: **75 kg**

Approval number according to Directive 94/20/EC: **e20*94/20*0786*00**

Foreword

This towbar is designed according to rules of safety traffic regulations. The towing hitch is a safety component and can be install only by qualified personnel. Any alteration or conversion of the towing hitch is prohibited and would lead to cancellation of design certification. Remove insulating compound and underseal from vehicle (if present) in the area of the matting surfaces of the towing hitch.

The vehicle manufacturer's specifications regarding trailer load and max. vertical cup load are decisive for driving, and values for the towing hitch cannot be exceeded.

D-value formula:

$$\frac{\text{Max trailer weight [kg]} \cdot \text{Max vehicle weight [kg]}}{\text{Max trailer weight [kg]} + \text{Max vehicle weight [kg]}} \times \frac{9,81}{1000} = D \text{ [kN]}$$